

FEATURED MODEL
1512UM18, 9" bowl depth

FEATURES

- * 18 gauge, 304 series stainless steel
- * Rear Drain Placement
- * Design allows for easy installation in standard 25" countertop
- * Sound deadening insulation and pads

OPTIONAL ACCESSORIES

Stainless Steel Sink Grids: 1512GRID

CODE/STANDARDS COMPLIANCE

cUPC Certificate

WARRANTY

Serenity Sinks Stainless sinks feature a LIMITED LIFETIME WARRANTY to be free of all manufacturing defects under normal use.

While Serenity endeavors to provide accurate information, all dimensions are nominal, cannot be guaranteed, and are subject to change or cancellation. Serenity Sinks assumes no responsibility for use of superseded or voided specifications.

JOB INFORMATION

Job Name: _____

Contact: _____

Date Specified: _____

Specifier: _____

Contractor: _____



NOMINAL DIMENSIONS Model 1512UM18 shown

OVERALL	BOWL DEPTH	DRAIN
14-15/16"x 12-5/8"	9"	3-1/2"

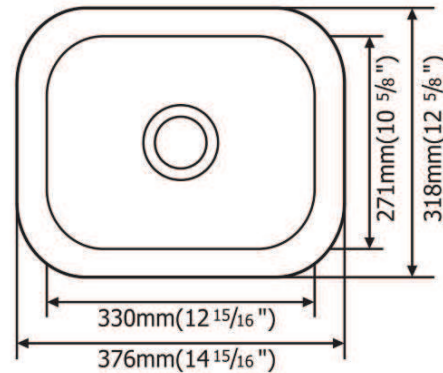

Architectural Surfaces Group

www.arcsurfacesgroup.com